

# **PORPHYRIN PHOTOVOLTAIC FUNCTIONALIZATION OF THE FULLERENE**

**SORANA D. BOLBOACĂ & LORENTZ JÄNTSCHI**

“Iuliu Hatieganu” University of Medicine and Pharmacy Cluj-Napoca  
& Technical University of Cluj Napoca

# Outline

Background

Idea

Design

Results

Work in progress

# Background

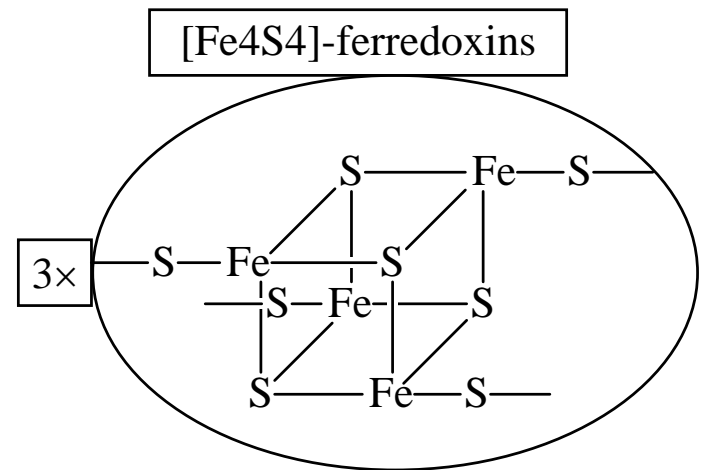
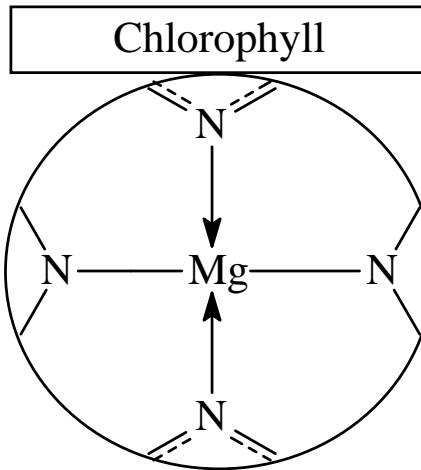

Fe, Cu, Mg –  
biological role

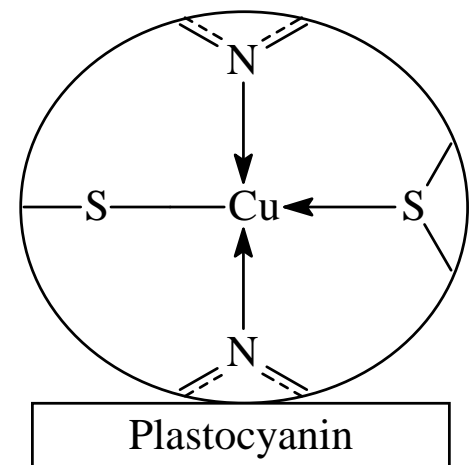
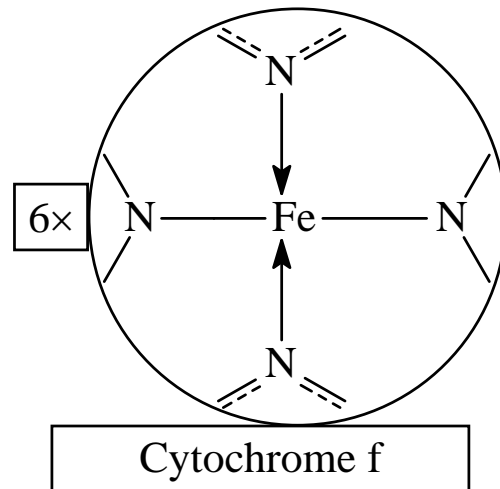
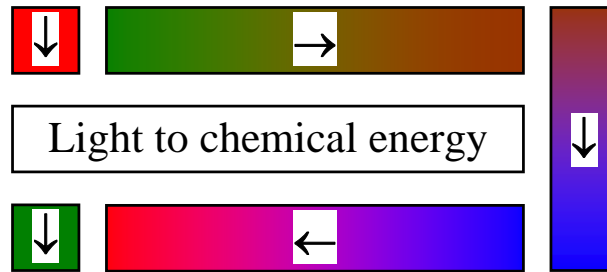

# Plants ‘Photosystem II’

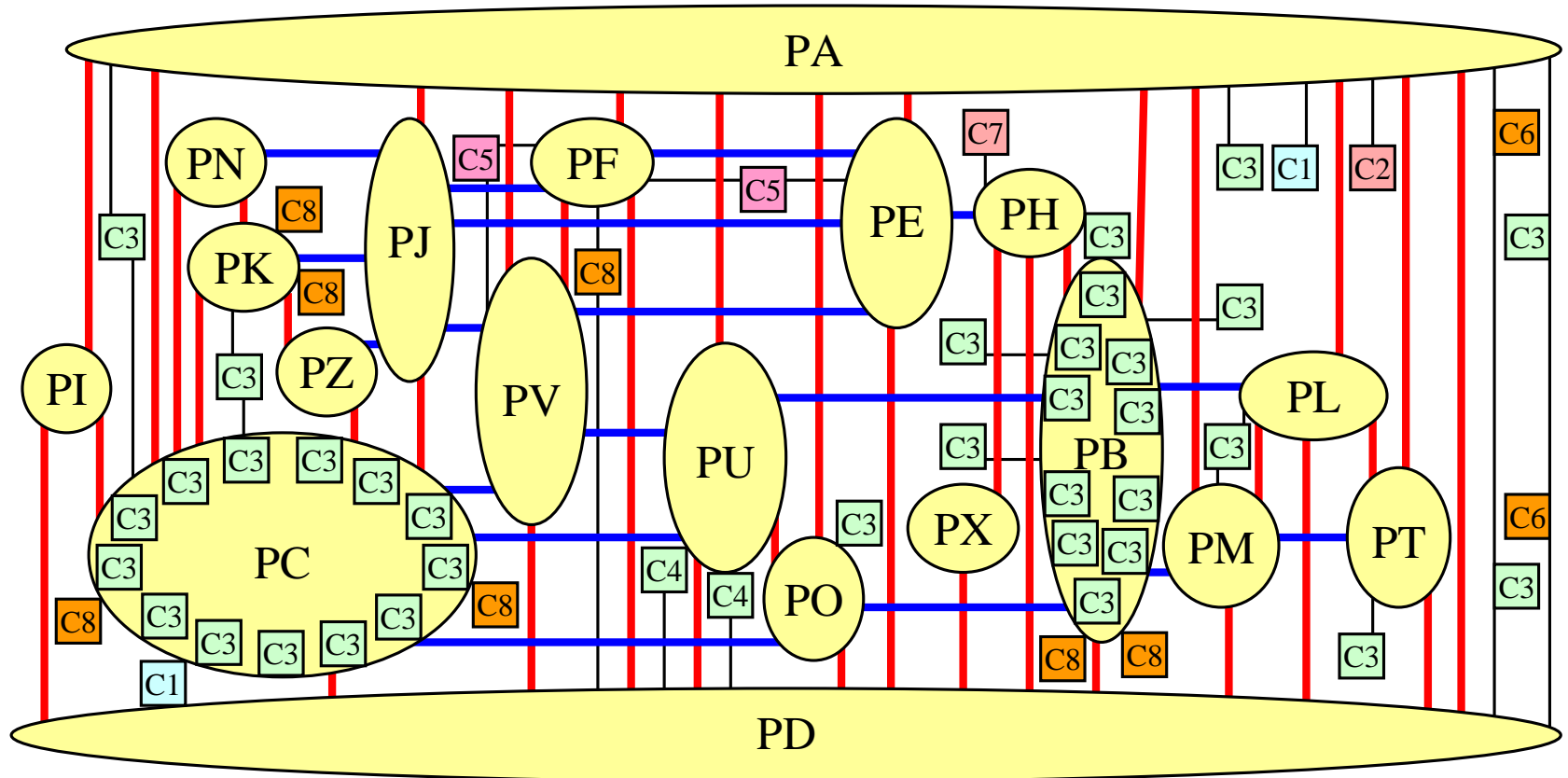

PA...PX: different proteins    C3: chlorophyll A    C5: haem like    C8: β-carotene

<http://www.ncbi.nlm.nih.gov/Structure/mmdb/mmdbsrv.cgi?Dopt=s&uid=26605>

# Sun's 'renewable' energy

Background

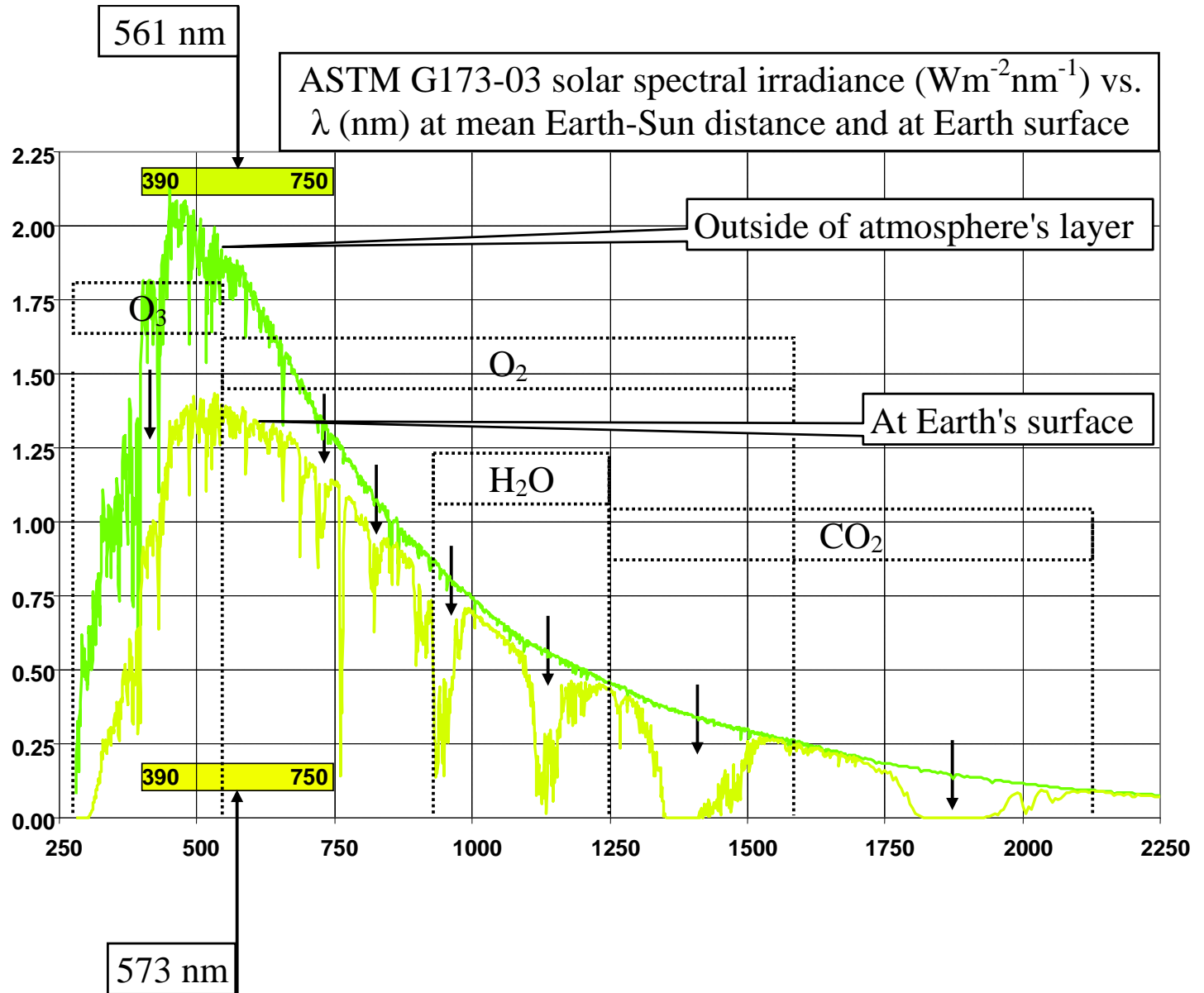

# What are you looking for?

- Source: Solar radiation
- Method: new molecular complex
- Ability: to absorb better the light in the range of wavelengths

Link:

2 porphyrins & 1 carbon nano disk (C96)

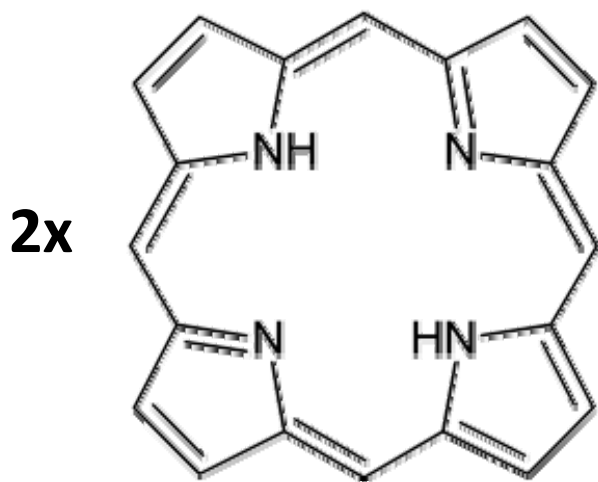

&

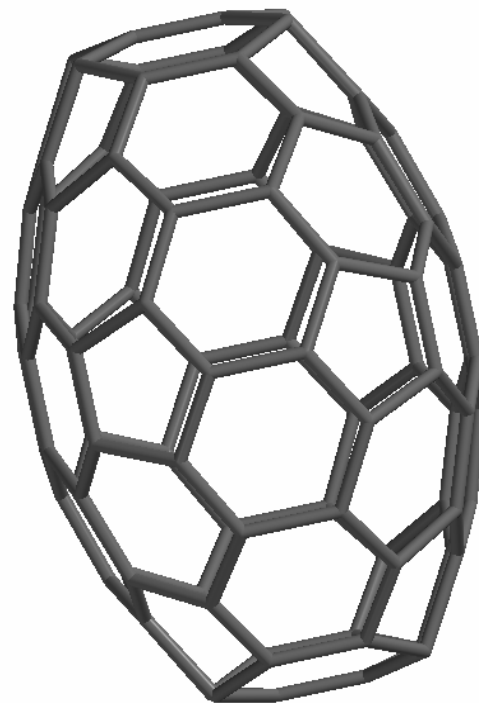

Geometry optimization: Hartree-Fock level of theory (standard orbital grid and 6-31 orbital grids)

Calculations: UV-VIS spectrum

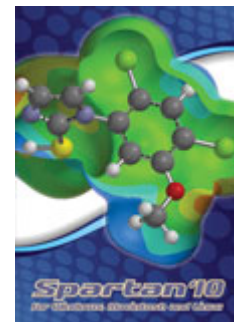

# Complex characteristics

**Weight:** 1994.176

**Dipole Moment:** 2.55 debye

**E-HOMO:** -2.49 eV

**E-LUMO:** 2.11 eV

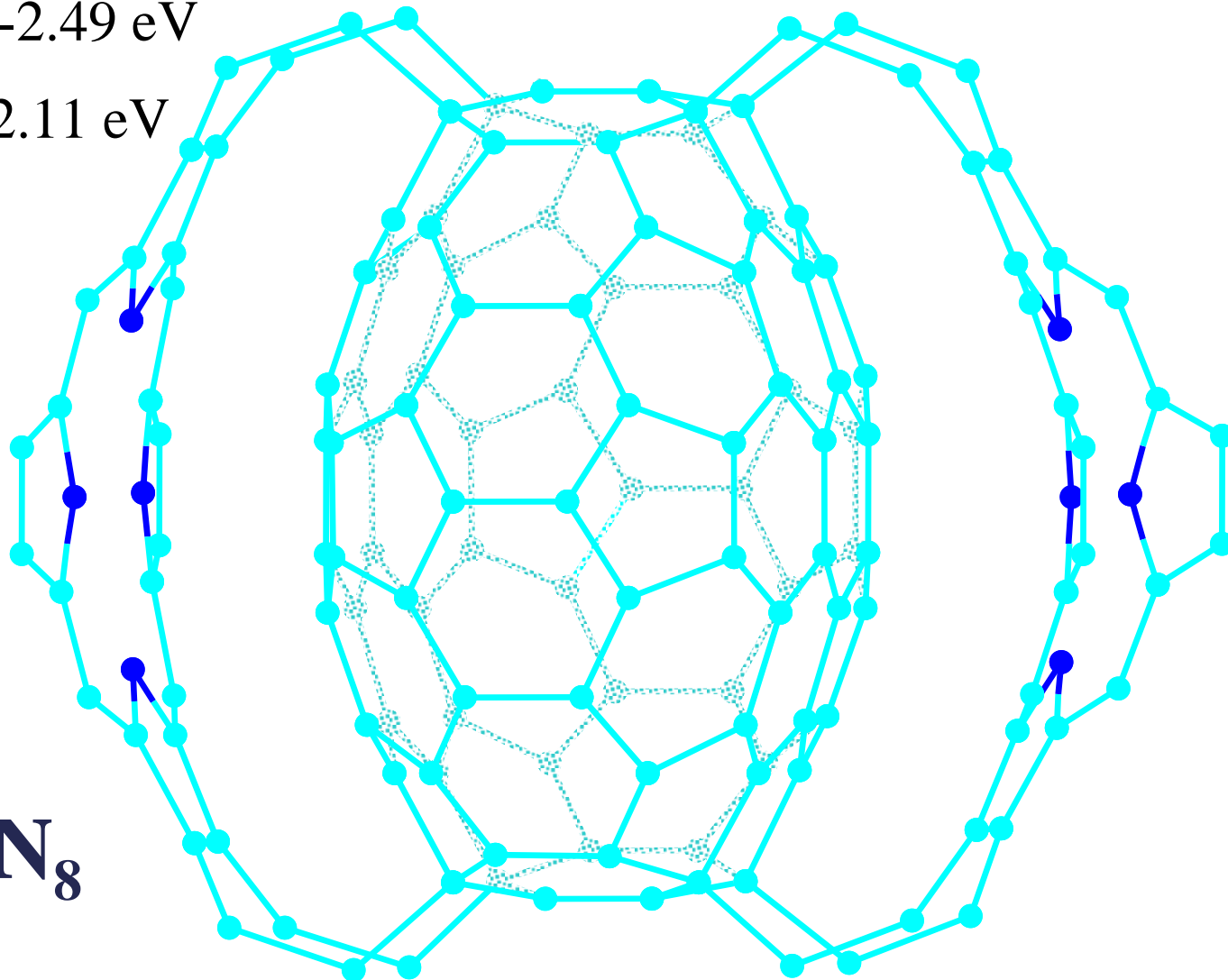

**C<sub>152</sub>H<sub>56</sub>N<sub>8</sub>**



# Apps: converting solar energy

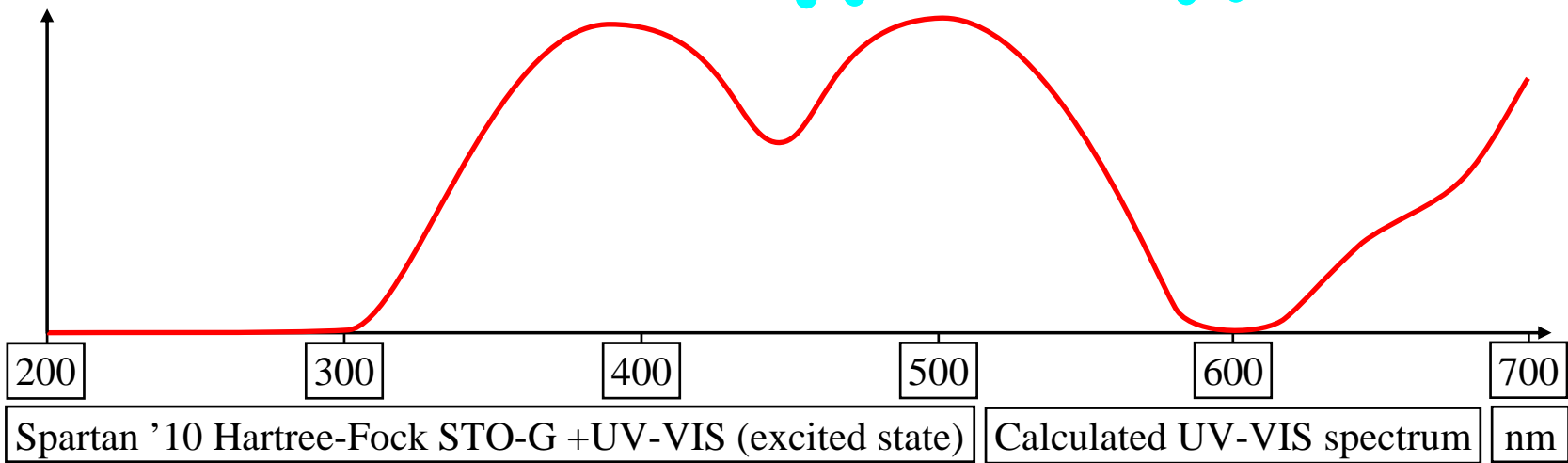
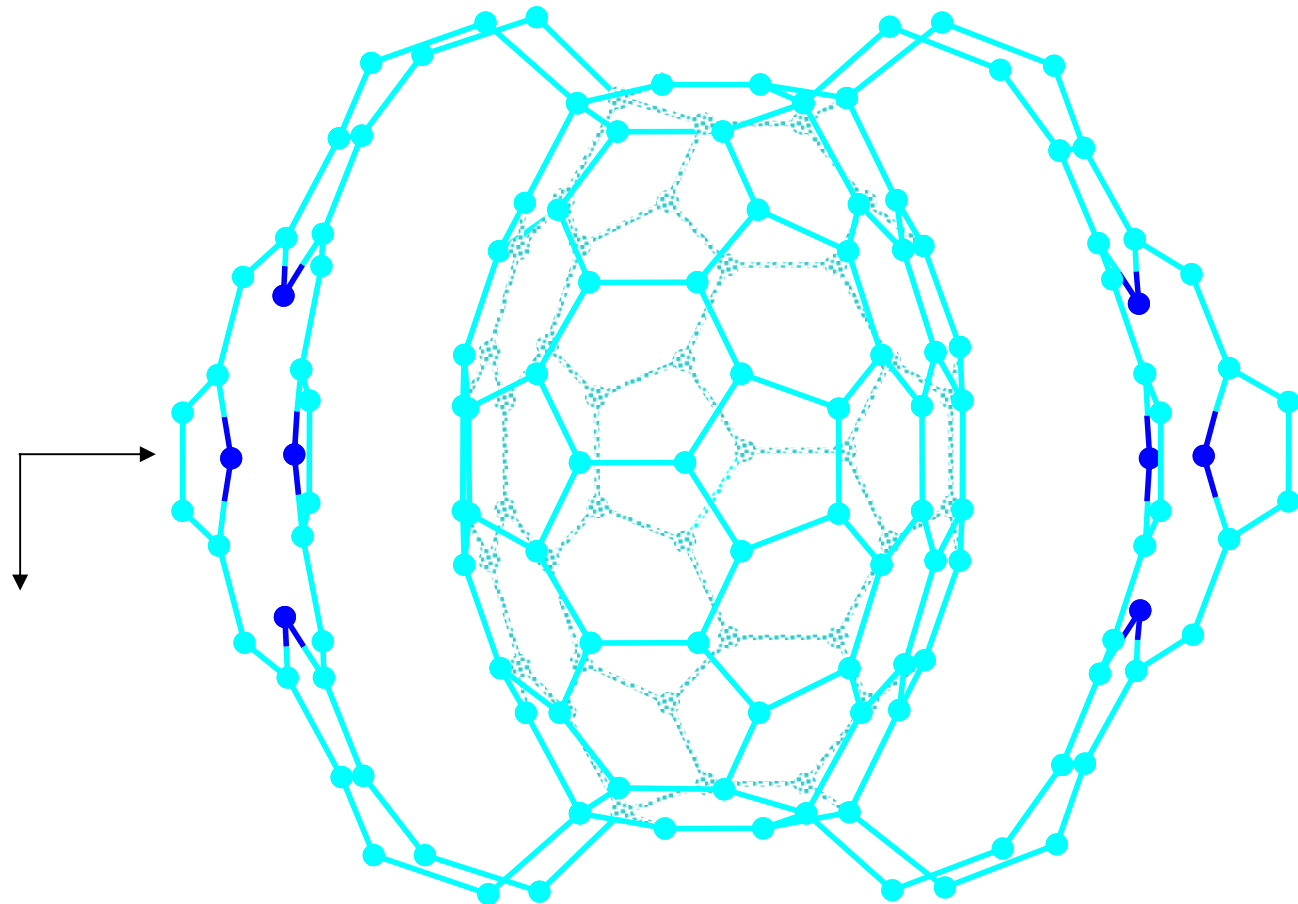

Weight: 2066.264

E-HOMO: -2.68 eV

E-LUMO: 1.90 eV

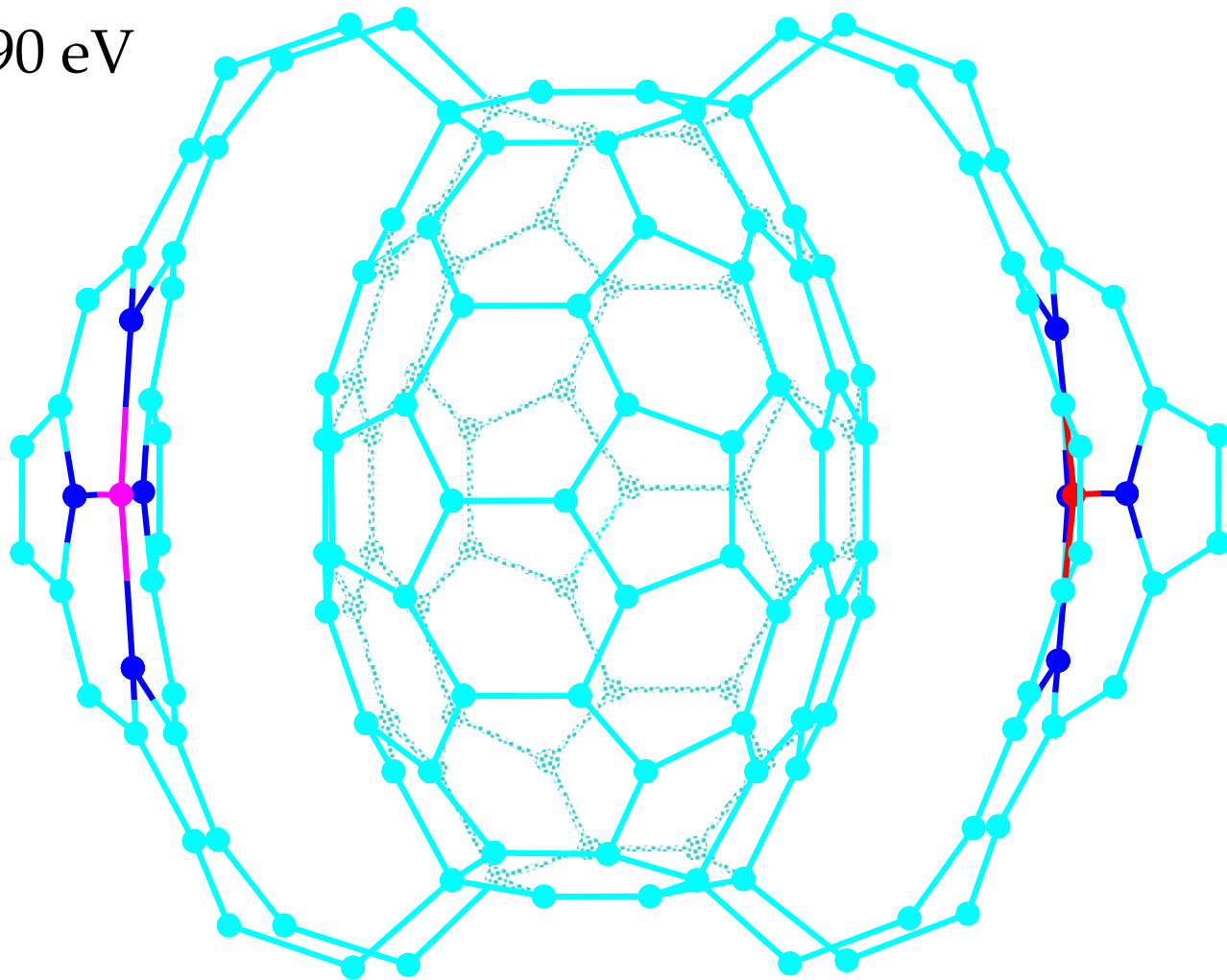

# You Have Just Seen ...

Porphyrin photovoltaic functionalization of the fullerene

**Thank you for your attention!**

---

## Bibliography

1. Jäntschi L, Bolboacă SD, Bălan M, Sestraş RE, 2011. Chlorophylls - natural solar cells. Bulletin UASVM Agriculture 68(1):181-187.
2. Ferreira KN, Iverson TM, Maghlaoui K, Barber J, Iwata S, 2004. Architecture of the photosynthetic oxygen-evolving center. Science 303(5665):1831-1837.
3. Jäntschi L, 2013. General Chemistry Course. AcademicDirect: Online.